

product specification

radio interference suppression filter: **NFK14-2A22**



- High insertion loss over a broad frequency range
- Optimised against asymmetric interferences
- 2-Stage design in order to improve the filter effect
- Self-extinguishing polycarbonate housing acc. to UL94V1
- Suitable for the tropics - epoxy resin casted
- Safety acc. to VDE, EN, UL, CSA

Application

Filters of the NFK14-2A22 series are used to suppress circuit-bound interferences in AC power lines. Interference pulses or interference voltages are dampened independently from their point of origin. To improve the filter effect they are designed with 2 stages, furthermore these filters are optimised against asymmetric interferences and have a high insertion loss on a broad frequency range.

typical connection scheme

optimised against asymmetric interferences

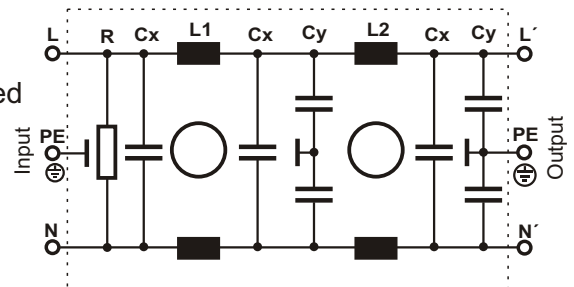

Functional principle

The filters of the NFK14-2A22 series are connected between the AC voltage supply and the consumer, which is susceptible to interference.

Because of the combination of chokes and film capacitors of the classes "X" and "Y" an effective suppression on a wide frequency range is achieved.

By the use of two ring core double chokes the filters are optimised for eliminating asymmetric interferences (typical connection scheme see above).

Insertion loss at 50

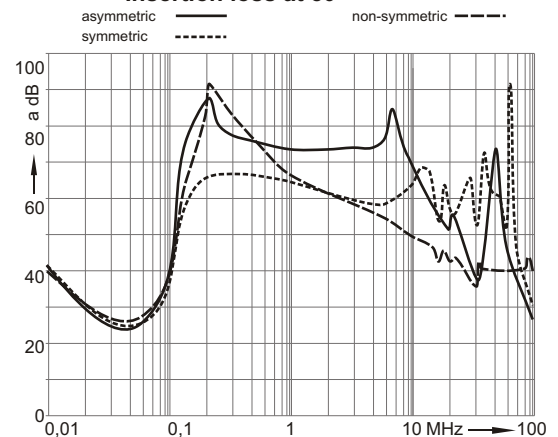

Design

Integrated into a plastics housing for mounting on a rail acc. to DIN 46277.

connection example

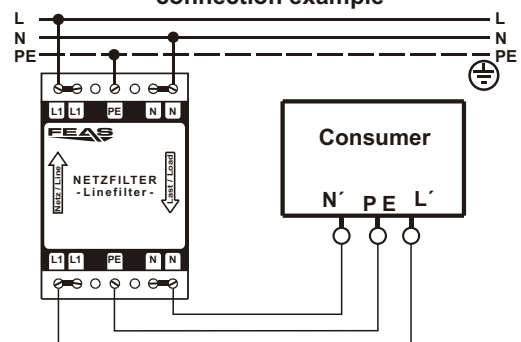

Please read the data sheets and the operating instructions for further information.