

product specification

radio interference suppression filter: **NFK855-8A31**



- High insertion loss over a broad frequency range
- Small enclosure design
- Using aluminium enclosure in order to improve the heat conduction
- Suitable for the tropics - epoxy resin casted
- Safety acc. to VDE, EN, UL, CSA

Application

Filters of the NFK855-8A31 series are used to suppress circuit-bound interferences in three-phase AC power lines without neutral conductor.

Interference pulses or interference voltages are dampened independently from their point of origin. The filters are build with 1 stage and have a high insertion loss on a wide frequency range.

typical connection scheme

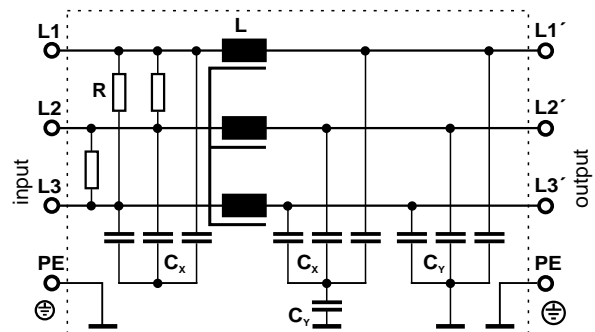

Insertion loss at 50

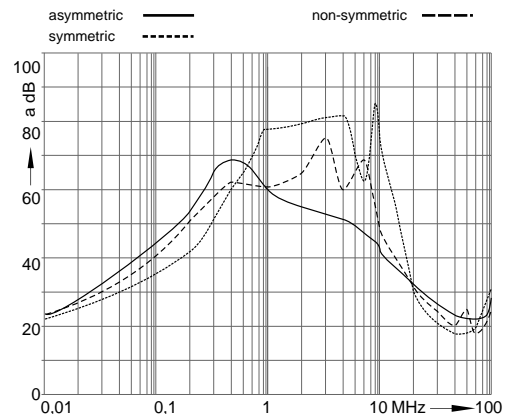

Functional principle

The filters of the NFK855-8A31 series are connected between the AC voltage supply and the consumer, which is susceptible to interference.

Because of the combination of chokes and film capacitors of the classes "X" and "Y", an effective suppression on a wide frequency range is achieved (typical connection scheme see above).

connection example

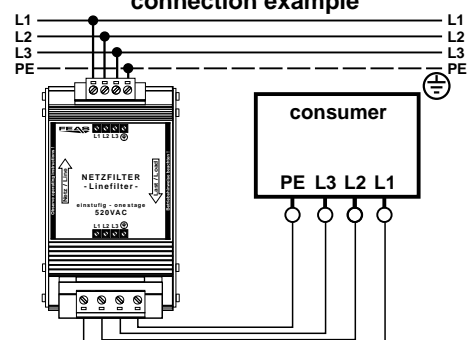

Design

Integrated into an aluminium housing for mounting on a rail acc. to DIN 46277 or wall mounting with screws.



Please read the data sheets and the operating instructions for further information.