

product specification

radio interference suppression filter: **NFK30-8A41**

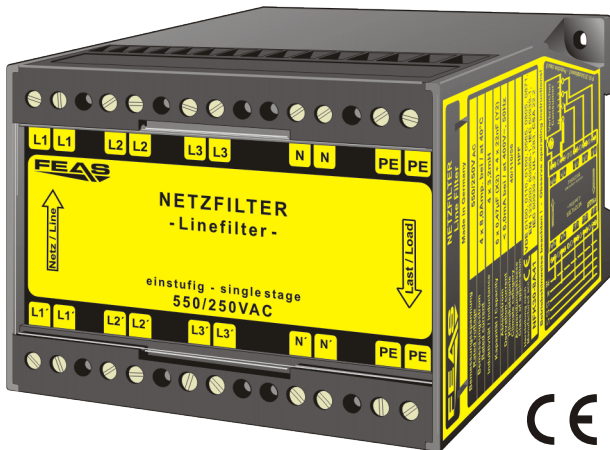

- High insertion loss over a broad frequency range
- Small enclosure design
- Self-extinguishing polycarbonate housing acc. to UL94V1
- Suitable for the tropics - epoxy resin casted
- Safety acc. to VDE, EN, UL, CSA

Application

Filters of the NFK30-8A41 series are used to suppress circuit-bound interferences in three-phase AC power lines with neutral conductor.

Interference pulses or interference voltages are dampened independently from their point of origin.

The filters are build with 1 stage and have a high insertion loss on a wide frequency range.

Functional principle

The filters of the NFK30-8A41 series are connected between the AC voltage supply and the consumer, which is susceptible to interference.

Because of the combination of chokes and film capacitors of the classes "X" and "Y", an effective suppression on a wide frequency range is achieved (typical connection scheme see above).

Design

Integrated into a plastics housing for mounting on a rail acc. to DIN 46277 or wall mounting with screws.

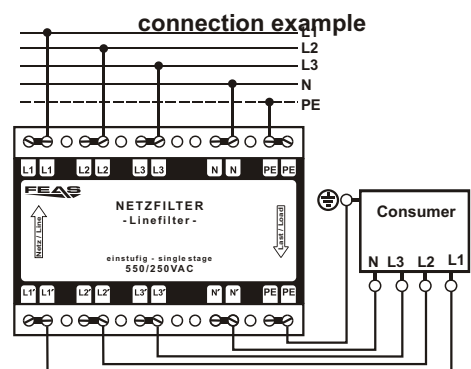
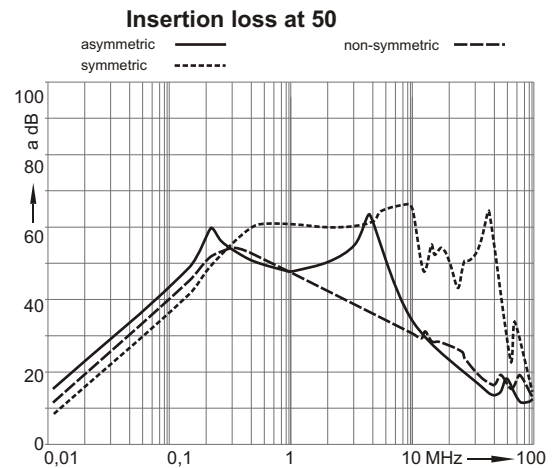
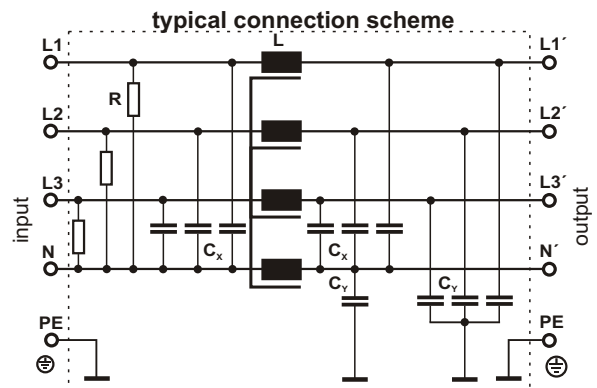

Please read the data sheets and the operating instructions for further information.