

Product specification

Switch mode power supply SNT1024

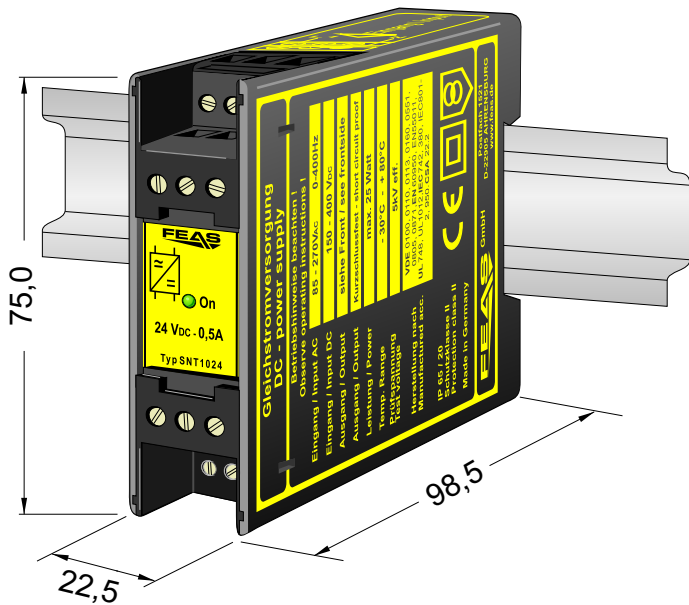

CE - konform

- Input range: 85 - 270 V_{AC} or 120 - 400V_{DC}
- Output voltage: 24V_{DC}
- Boostfunction 200%
- Overload and open circuit protected
- Extra low safety potential
PELV (EN 50178) SELV (EN 60950)
- Operating status shown by LED
- Parallel operatin possible
- Vibration proof, suitable for the tropics -
exposy resin casted
- Output separated according to VDE0551
- Conforms to EMC and low voltage directive
- Short circuit proof
- Safety according to VDE, EN, UL, CSA

Application

The switch-mode power supplies of the SNT10 series are powerful and robust devices to power sensitive loads in a hard industrial environment. These features result from the modern construction with a good radio shielding and high reliability integrated in a functional and stable casing. The short circuit proof output DC voltage of the SNT1024 is 24 V. This power supply is optimally suited for loads requiring high starting currents.

Functional principle

In the power supply SNT1024 a flyback converter operates to transform the energy in two steps. During the conducting phase the diode is blocking, the inductor is energized and a magnetic field establishes. There is no electrical transmission; the consumer load is supplied with energy from the capacitor. When the switching transistor opens, the blocking phase begins. The current in the inductor cannot change immediately, discharges through the diode and a negative voltage establishes at the inductor. Now operating like a power source the inductor reloads the capacitor and supplies the consumer with energy. The energy flows from the inductor into the capacitor and the consumer and through the conducting diode back to the inductor.

Design

Completely embedded with resin in a plastics housing for mounting on a rail.

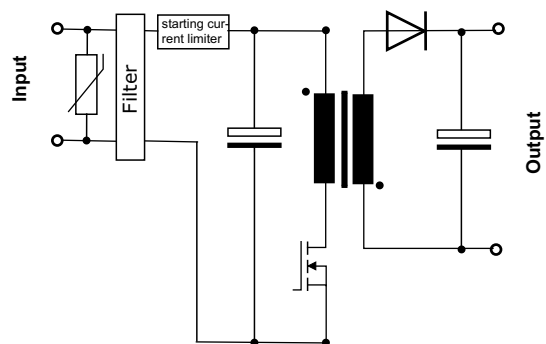
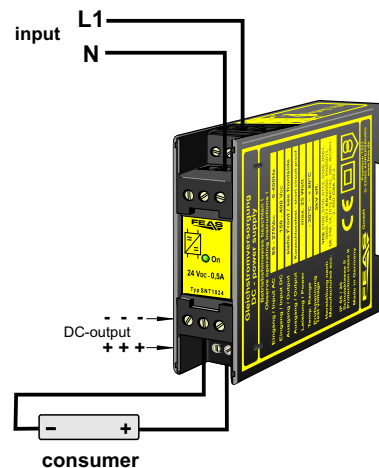

Please read the data sheets
and the operating instructions
for further information

FEAS

Postfach 1521
D - 22905 Ahrensburg

Phone: +49 4102 42082
Telefax: +49 4102 40930

E-Mail : sales@feas.com
Internet: www.feas.com