

Radio interference suppression filters

2-Lines 1-Stage

Type NFK12-4A21

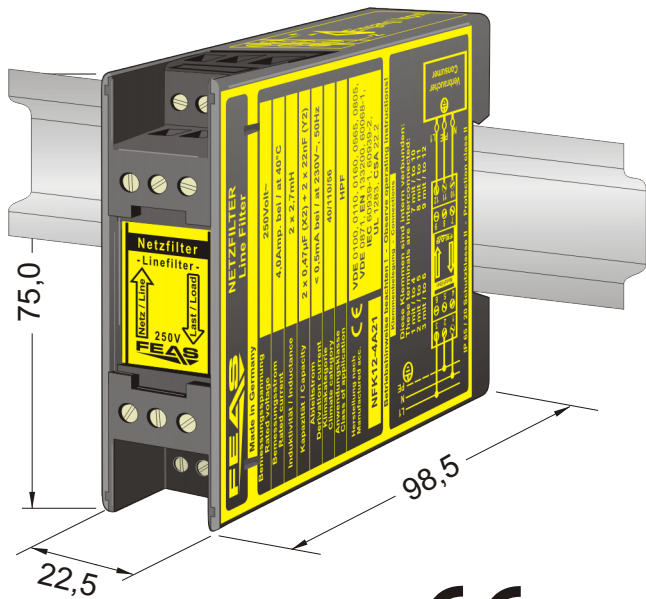

CE - conform

- High insertion loss over a broad frequency range
- extra slim enclosure design, only 22,5mm wide
- Self-extinguishing polycarbonat housing in acc. to UL94V1
- Suitable for the tropics - Epoxy resin casted
- Safety acc. to VDE, EN, UL, CSA

Technical Data

Electrical data	
Rated voltage U_R	see table below
Frequency	see table below
Rated current I_R	see table below
Overload current	$1,5 \times I_R$ $t < 2$ Min. 3 x / h
Inductance L_R	see table below
Capacity C_R	see table below
Derivation current	$< 0,5$ mA at 230V~, 50Hz
Discharge resistor	ca. 1M
Operating data	
Duty circle	100%
Operating temperature range	-40°C to +85°C
Derating	-
Storage temperature range	-50°C...+105°C
Cooling	self cooling recommended respective distance 15mm each
Safety devices	
Fuse for input	-
Fuse for output	-
Overload protection	-
MTBF	> 380.000 h
Safety data	
Test voltage	2,5kV- (Conductor - PE)
Protection class	Class 2 (EN 60950)
Extra low safety potential	-
Ambient humidity	95% relative humidity, yearly average dewing allowed for use in tropical ambient
Protective class enclosure	IP 65
Protective class terminals	IP 20 (VGB4)
Vibration proof	> 30 g at 33Hz in X,Y and Z, acc. to IEC 60068-2-27
Applied construction regulations	
according to VDE	VDE 0100, 0110, 0113, 0551, 0160/W2, 0806
IEC	IEC 60939-1, IEC60939-2, IEC60068-2-3 IEC 60068-2-11-52, IEC 60529, IEC 380
EN	EN133200, EN60068-1 EN61000-6-1-2-3-4, EN50178 EN55011, EN50204, EN61558-2-17 EN60204, EN60529, EN61000-4-2-3-4-5-6-8-11 EN60068-1, EN60068-2-1-2-3-6-27-30 EN45501, EN50021
CSA / UL	CSA-C 22.2 / UL1283, UL94V1
Mechanics	
Mounting	On rails acc. to DIN 46277

Type	NFK12-4A21
Rated voltage	250VAC
Frequency	50 - 60Hz
Rated current	4,0Amp. at 40°C
Inductance	L1 2x2,7mH
Capacity	2 x 0,47 μ F(X2) 2 x 22nF(Y2)
Dimensions (W x H x D)	22,5x75x98,5
Weight	approx. 0,35kg
Order-No.	51004

